

POMPE SOMMERSE PER USO DOMESTICO

SUBMERGED PUMPS FOR DOMESTIC USE

WELL P 100 BRASS - 4"





WELL C 80-150 - 5"



 Pompe sommerse per uso domestico adatte al pompaggio di acqua pulita. Albero motore in acciaio inox AISI 420. Doppia tenuta meccanica in bagno d'olio. Isolamento classe B. Protezione: IP 68. Temperatura massima dell'acqua da pompare 30 °C. Il modello **WELL P 100 BRASS** ha corpo mandata e girante periferica in ottone, motore a bagno d'olio, cavo di alimentazione da 15 metri con control box, condensatore e protezione a riarmo manuale posizionati alla fine del cavo. I modelli **WELL C** hanno giranti in noryl e cavo di alimentazione da 15 metri con control box, condensatore e protezione a riarmo manuale posizionati alla fine del cavo. Disponibili con o senza galleggiante.

 Submerged pumps for domestic use suitable to pump clean water. Motor shaft in stainless steel AISI 420. Double mechanical seal in oil chamber. Insulation class B. Protection class: IP 68. Max. temperature of the pumped liquid 86 °F (30 °C). The model **WELL P 100 BRASS** has discharge body and peripheral impeller in brass, oil bathed motor, 15 metres supply cable, control box with capacitor and manual reset protection positioned at the end of the cable. The models **WELL C** have noryl impellers, 15 metres supply cable, control box with capacitor and manual reset protection positioned at the end of the cable. Available with or without float-switch.

 Pompes de forage pour le pompage d'eau claire. Arbre moteur en acier inox AISI 420. Double garniture mécanique en chambre d'huile. Isolation classe B. Protection: IP 68. Température max. de l'eau pompée 30 °C. Le modèle **WELL P 100 BRASS** a corps de refoulement et roue périphérique en laiton, moteur à bain d'huile, câble électrique de 15 mètres, control box avec condensateur et protection à réarmement manuel à la fin du câble. Les modèles **WELL C** ont roues en noryl, câble électrique de 15 mètres, control box avec condensateur et protection à réarmement manuel à la fin du câble. Disponibles avec ou sans flotteur.

 Unterwasserpumpen für die Hauswasserversorgung für das saubere Wasser. Antriebswelle aus rostfreiem Stahl AISI 420. Ölgekühlte Doppel-Gleitringdichtung. Isol. Klasse B. IP 68 Schutz. Max. Temperatur der Flüssigkeit 30 °C. Modell **WELL P 100 BRASS**: Auslaßgehäuse und Peripheralrad aus Messing, Ölgekühlter Tauchmotor, Schutzvorrichtung mit manueller Rückstellung im Netzkabel. 15 Meter Kabel H07RNF. Modellen **WELL C**: Laufräder aus Noryl, Schutzvorrichtung mit manueller Rückstellung im Netzkabel. 15 Meter Kabel H07RNF. Mit oder ohne schwimmerschalter.

Modello Model Modèle Modell	Potenza Power Puissance Pferdestärke		Tensione Voltage Bobinage Spannung	A	Numero stadi Number stages Nombre étages Stufenzahl N.	Portata - Capacity - Débit - Fördermenge (l/min)														
	HP	kW				10	20	30	40	50	60	70	80	90	100					
	Prevalenza - Head - Hauteur - Förderhöhe (m)																			
WELL P 100 BRASS	1	0,75	230/50/1	6,0	1	49	40	29	19	8										
WELL C 80	0,8	0,59	230/50/1	4,4	4	47	44	42	38	35	32	27	23	19	12					
WELL C 150	1,5	1,1	230/50/1	6,5	7	65	60	56	52	48	43	37	32	25	19					

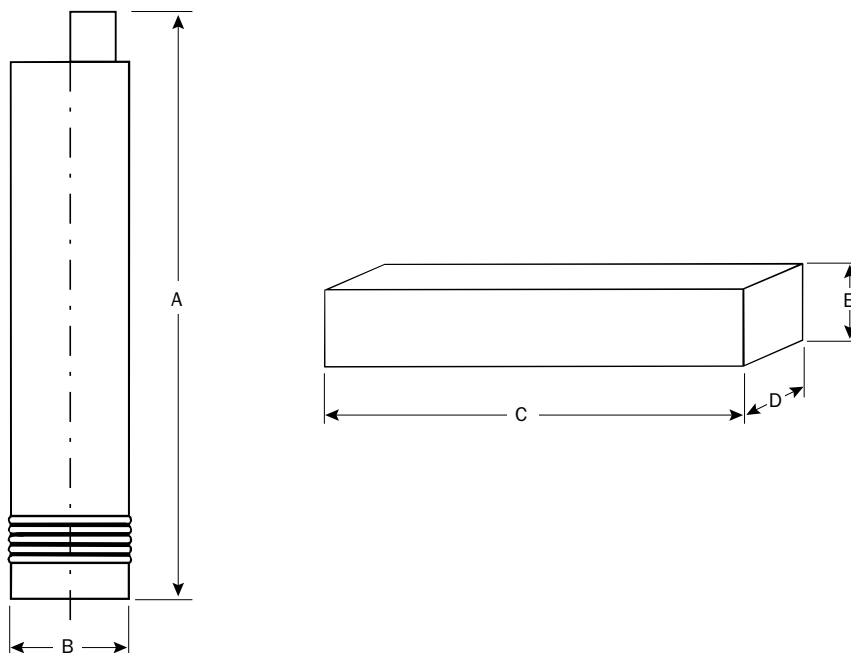
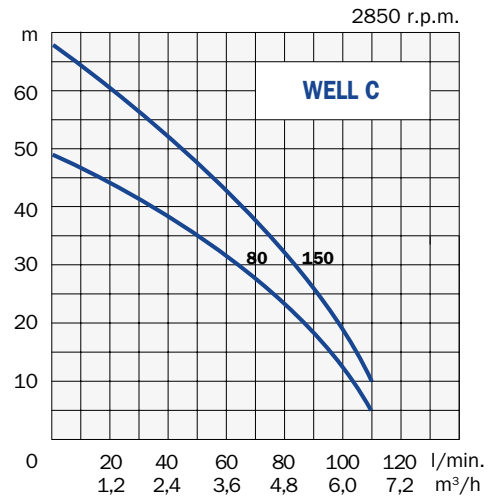
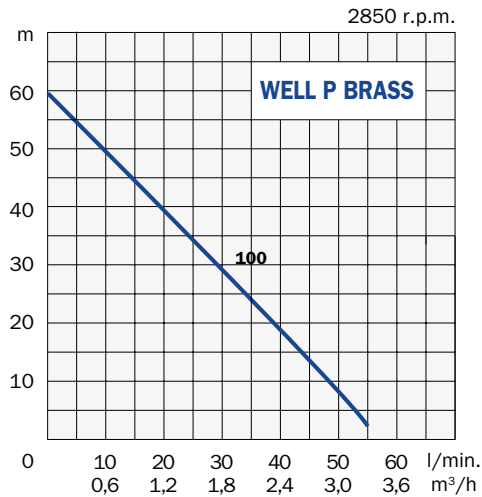

Modello Model Modèle Modell	Mandata Discharge Refoulement Druck-Seite	Dimensioni - Dimensions - Masstabelle					Peso Weight Poids Gewicht kg
		mm					
		A	B	C	D	E	
WELL P 100 BRASS	1" - DN 25	495	95 (4")	585	265	290	14
WELL C 80	1"1/4 - DN 32	500	128 (5")	615	270	200	15
WELL C 150	1"1/4 - DN 32	570	128 (5")	615	270	200	19